



Design by
STUDIO F·A·PORSCHE





A QUANTUM LEAP IN UV-TECHNOLOGY

UVA LEDs and Beauty LEDs

Aspherical glass lenses

Optimal spectral combination

Homogeneous illumination

Consistently high performance

Reduced power consumption

Based on the motto "Sunshine meets design", KBL, in cooperation with the Studio F. A. Porsche, has introduced a new era of solarium design with the P9. With the P9S, KBL is now setting new standards in UV-technology for the face and décolleté. Earlier UV-Systems generate unwanted heat during a tanning session as a result of infrared radiation, which often leads to reddened or tense skin after sunbathing. The P9S's innovative LED-based SunSphere System avoids this unwanted infrared radiation and only uses the wavelengths desired during tanning.

Homogeneously distributed via aspherical glass lenses. Blue UVA LEDs guarantee excellent direct pigmentation for an immediately visible tan. Red Beauty LEDs soothe the skin while tanning. And yellow UVB special lamps build up pigments. The perfect spectral combination for an incomparable tanning experience. In addition, the new SunSphere System offers a consistently high LED output, makes high pressure bulb changes unnecessary and drastically reduces your power consumption.



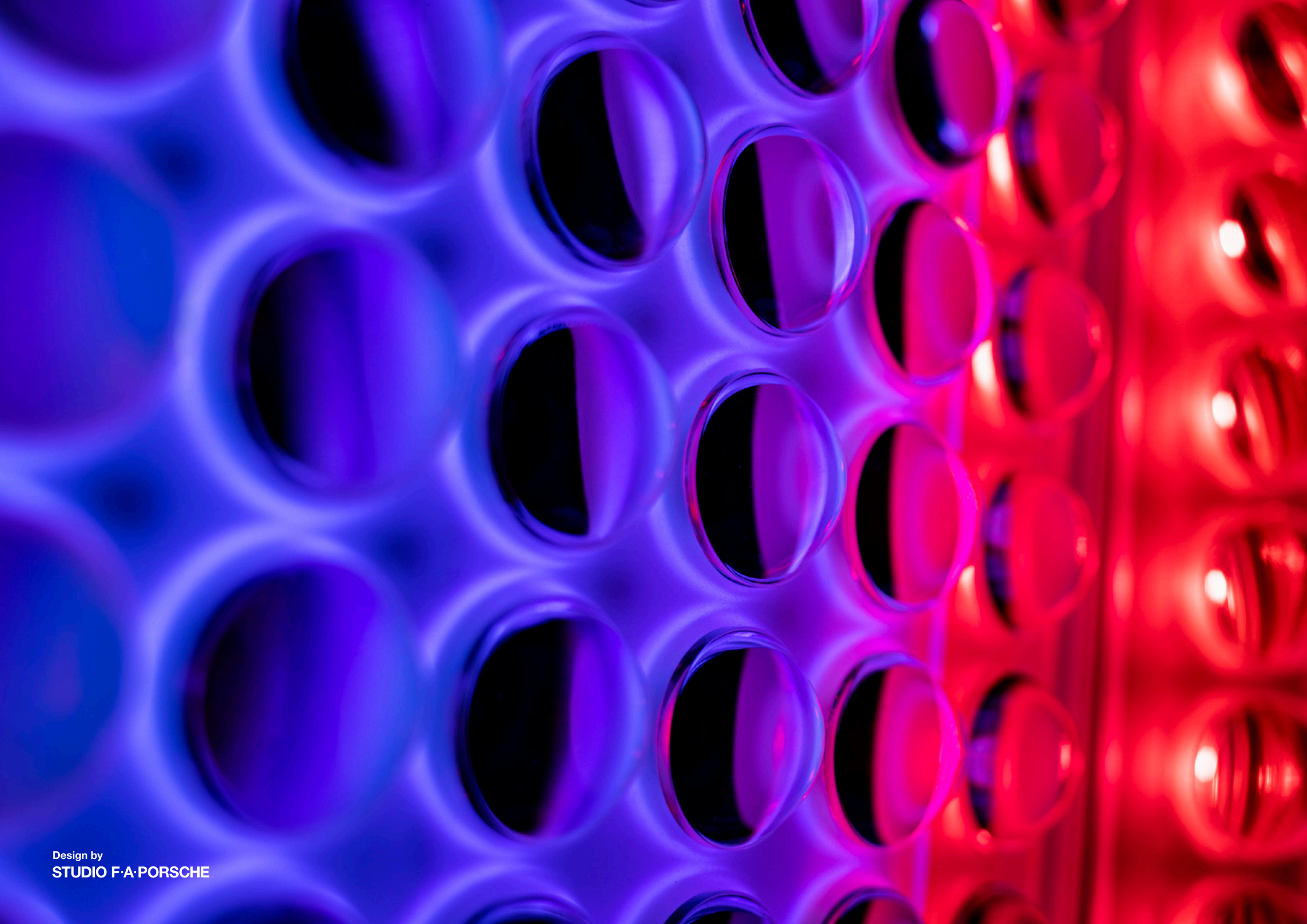

P9S

THE FUTURE OF SUNSHINE

SUNSPHERE



SunSphere Facials



SunSphere Shoulders



SunSphere UVA-LEDs



SunSphere Beauty LEDs

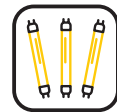

UVB-ThinLights

It's immediately obvious that it's a quantum leap in the field of spectral technology. High-performance LEDs only produce the wavelengths desired for a beautiful tan and a gentle tanning experience.

At the same time, aspherical lenses in front of the LEDs guarantee an absolutely homogeneous illumination of the face and décolleté. Progress that is immediately noticeable and, with the P9S, was also implemented in shoulder area.

Features



Matrix Light



Video Player



Wireless Charging



Intelligent Control System

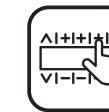

Easy Control



Beauty Booster HyperRed

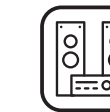

Sound System



Mega Voice



Bluetooth



Aqua Cool



Aroma



Air Condition

SUN IN BEST SHAPE

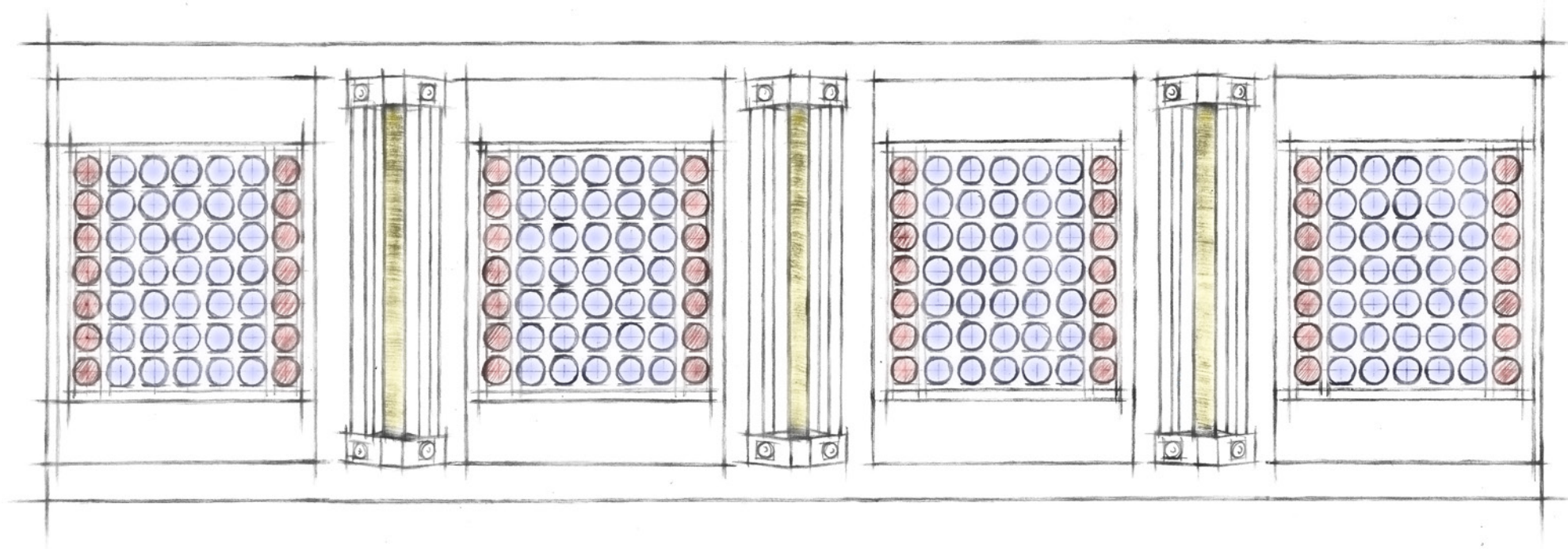

140 UVA LEDs

A beautiful tan just the way you like it. 140 blue UVA LEDs guarantee an optimally dosable direct pigmentation of the face and décolleté.

3 UVB SPECIAL LAMPS

The perfectly balanced output from three yellow UVB special lamps builds up new color pigments.

56 BEAUTY LEDs

With 56 red Beauty LEDs, the P9S provides skin care for the face and décolleté even while sunbathing and stimulates the oxygen supply in the skin at the same time. For a beautiful complexion and a silky smooth skin.



SunSphere
Facials



THOUGHT-OUT TO THE LAST DETAIL

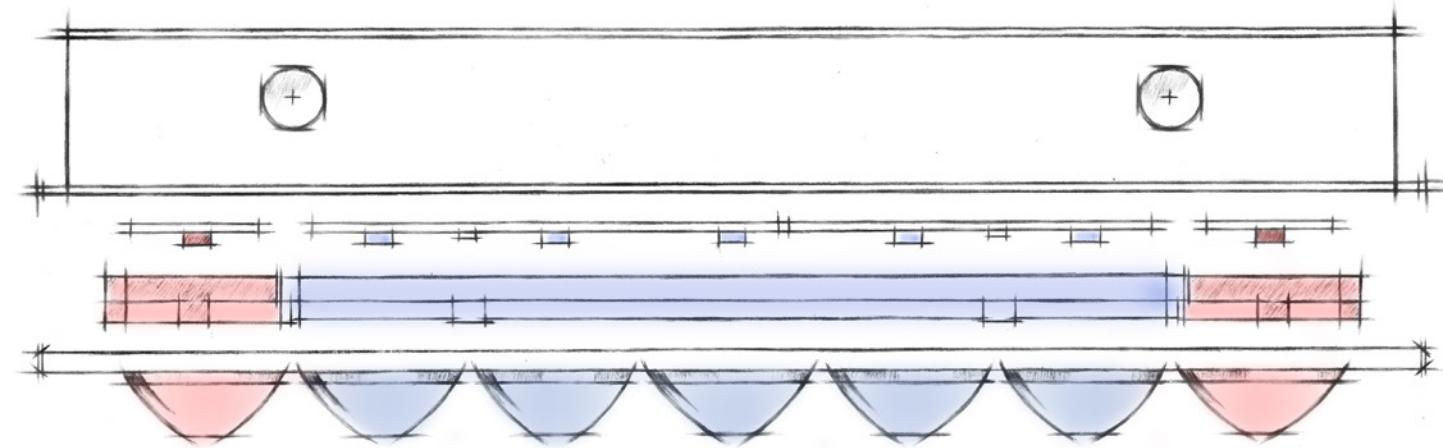

The innovative heat sink makes fans redundant and reduces noise generation for a relaxing experience.

Each of the four SunSphere facials combines special boards with a perfectly optimized spectral combination of UVA LEDs and Beauty LEDs.

An acrylic shield seals off the high-power LEDs to create a dust-free environment and eliminates the need for cleaning.

The filter glass with 49 aspherical glass lenses offers an optimal light distribution for the face and décolleté, without any hotspots.

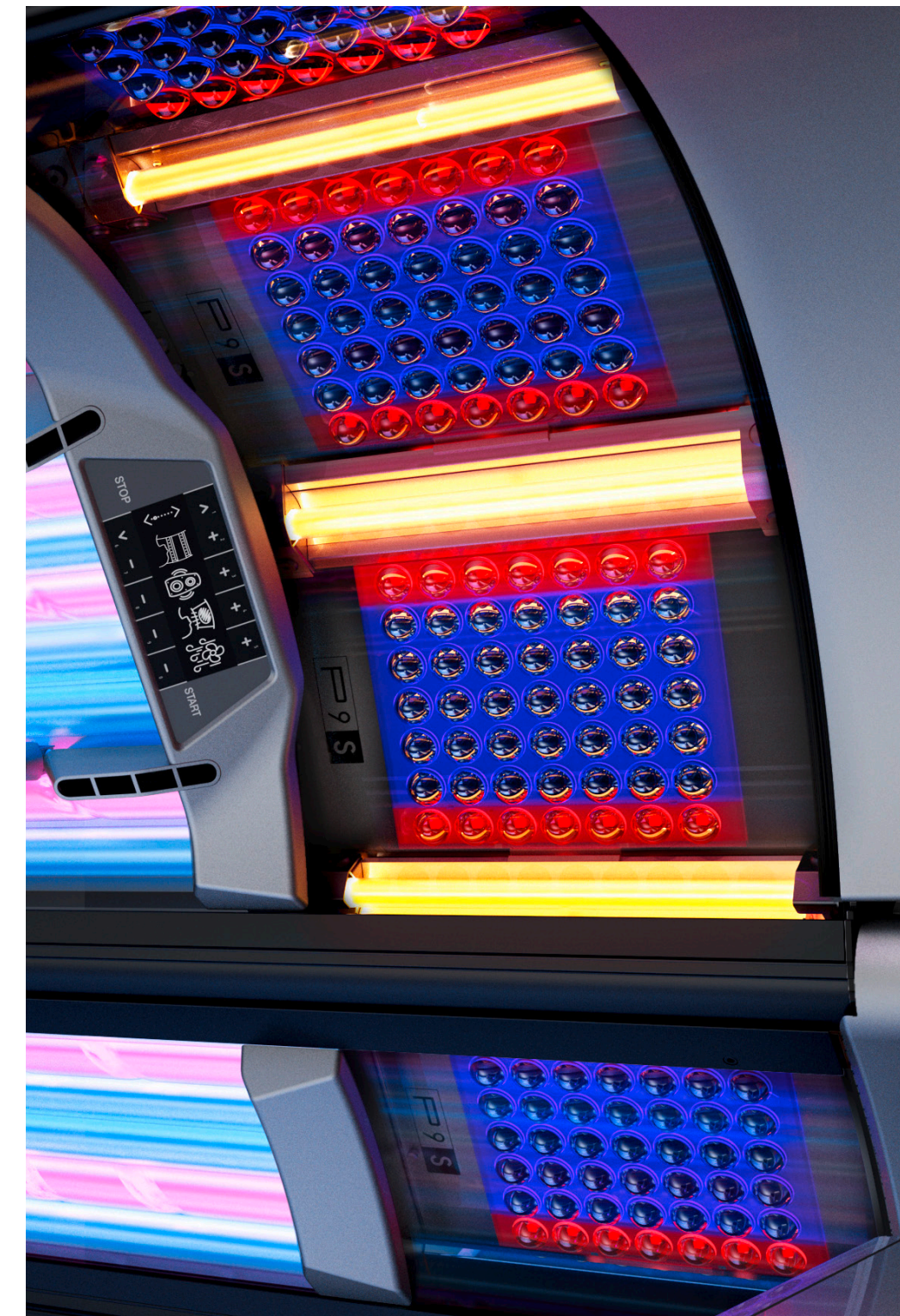

ENERGY EFFICIENT

Compared to conventional high-pressure Systems with UV bulbs, the LED-based SunSphere technology from KBL reduces power consumption by up to 80%.

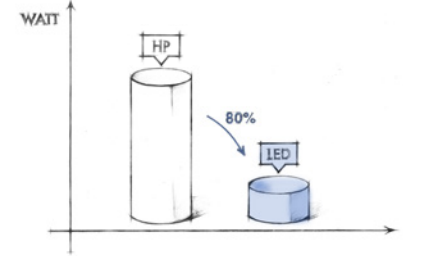

LONG LASTING PERFORMANCE

Conventional high pressure bulbs must be replaced at regular intervals and show a significant drop in output over time. The lifetime of the high-power LEDs within the SunSphere Systems is up to 25 times longer, with virtually no loss in tanning performance.

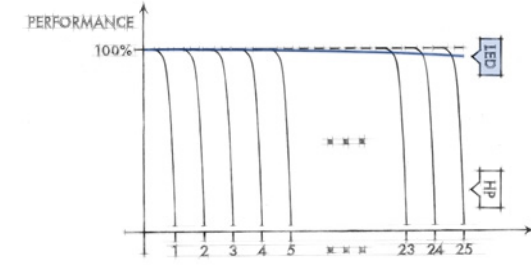

HOMOGENEOUS ILLUMINATION

Compared to conventional UV Systems, the SunSphere LEDs provide a much more homogeneous illumination of the face and décolleté. With no hotspots whatsoever.

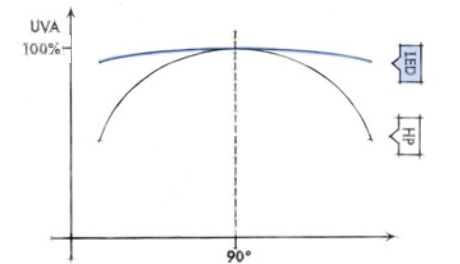

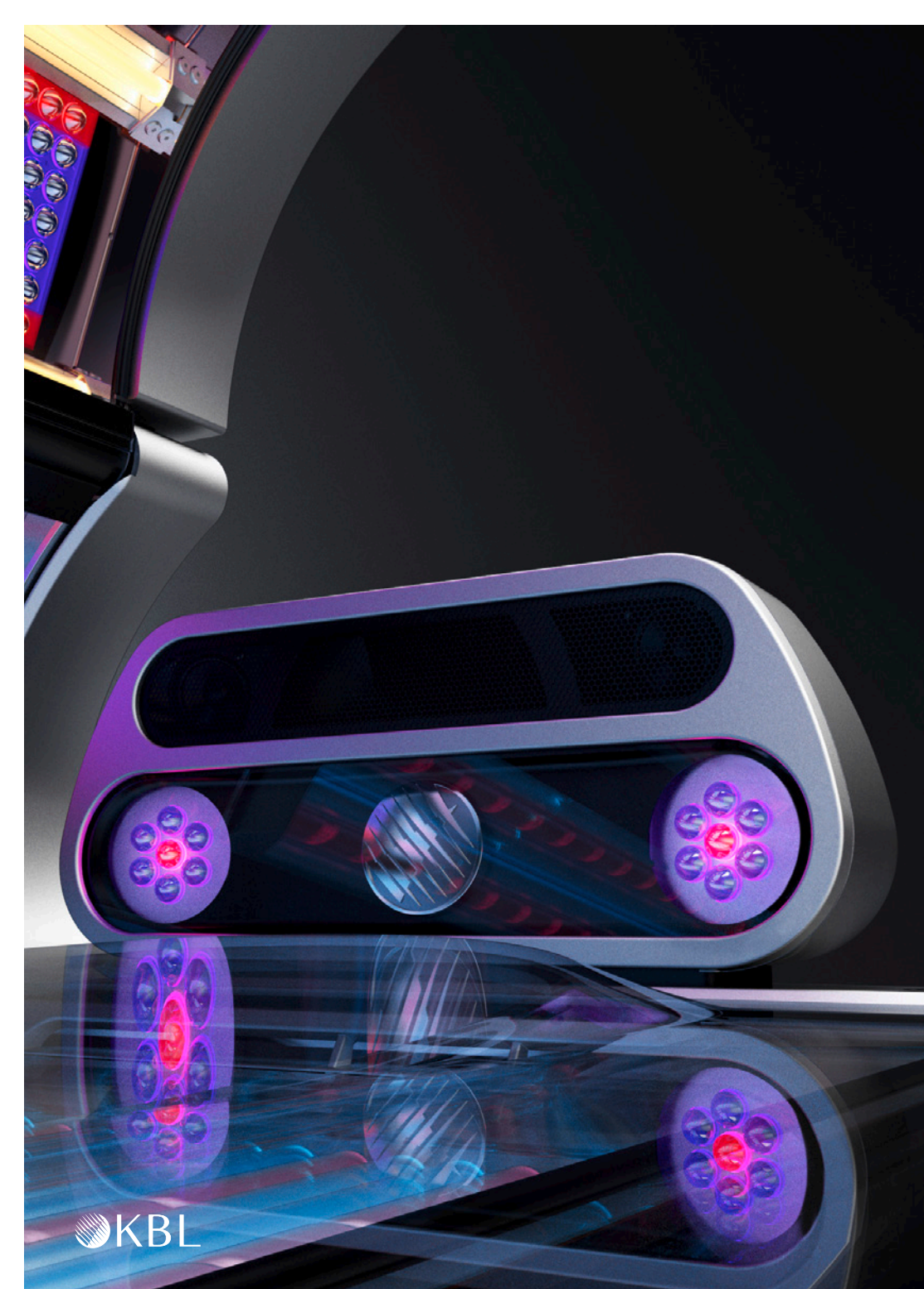

KBL

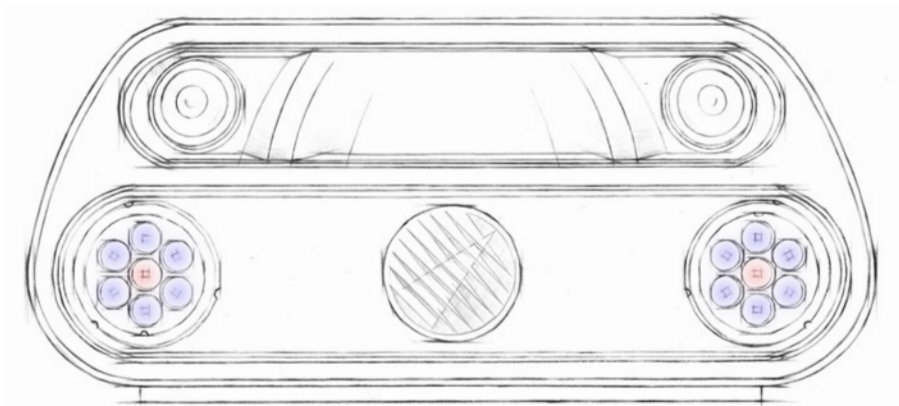

PERFECT SYMBIOSIS

The new SunSphere System consisting of high-performance LEDs and aspherical glass lenses is also implemented in the shoulder area. A spectral combination that guarantees beautiful complexion. The integrated Sound System ensures a brilliant sound experience. And a voice assistant guides through the operating functions.



SunSphere
Shoulders

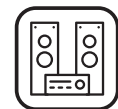

Sound
System



Mega
Voice

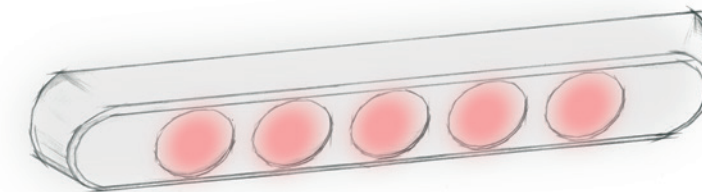

SMOOTH FEELING

All sunlight concepts for the body area are each supplemented by optimally distributed HyperRed Beauty Boosters. Extra intensive red light for a pleasant skin sensation and skin care when sunbathing.



Beauty
Booster
HyperRed

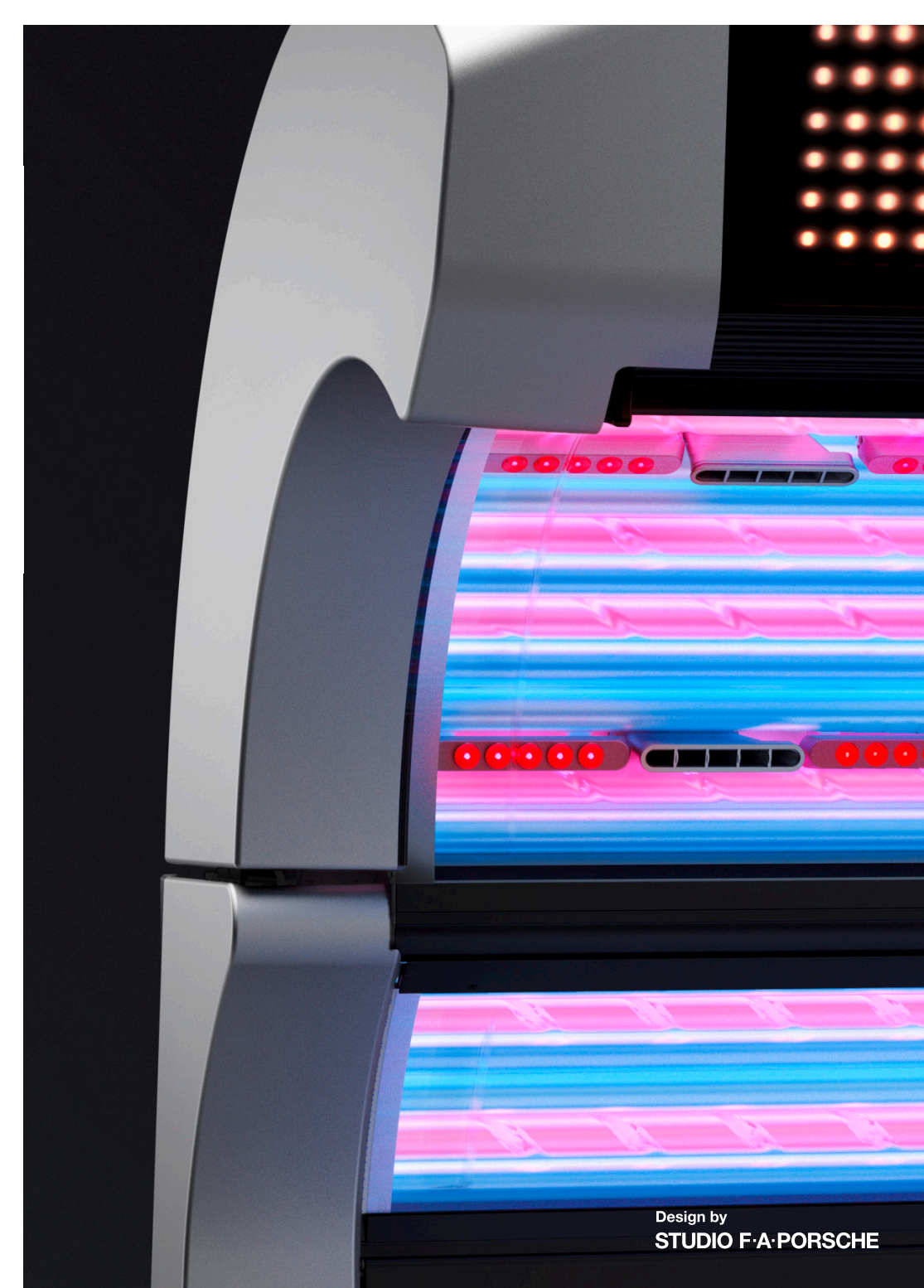

Design by
STUDIO F·A·PORSCHE

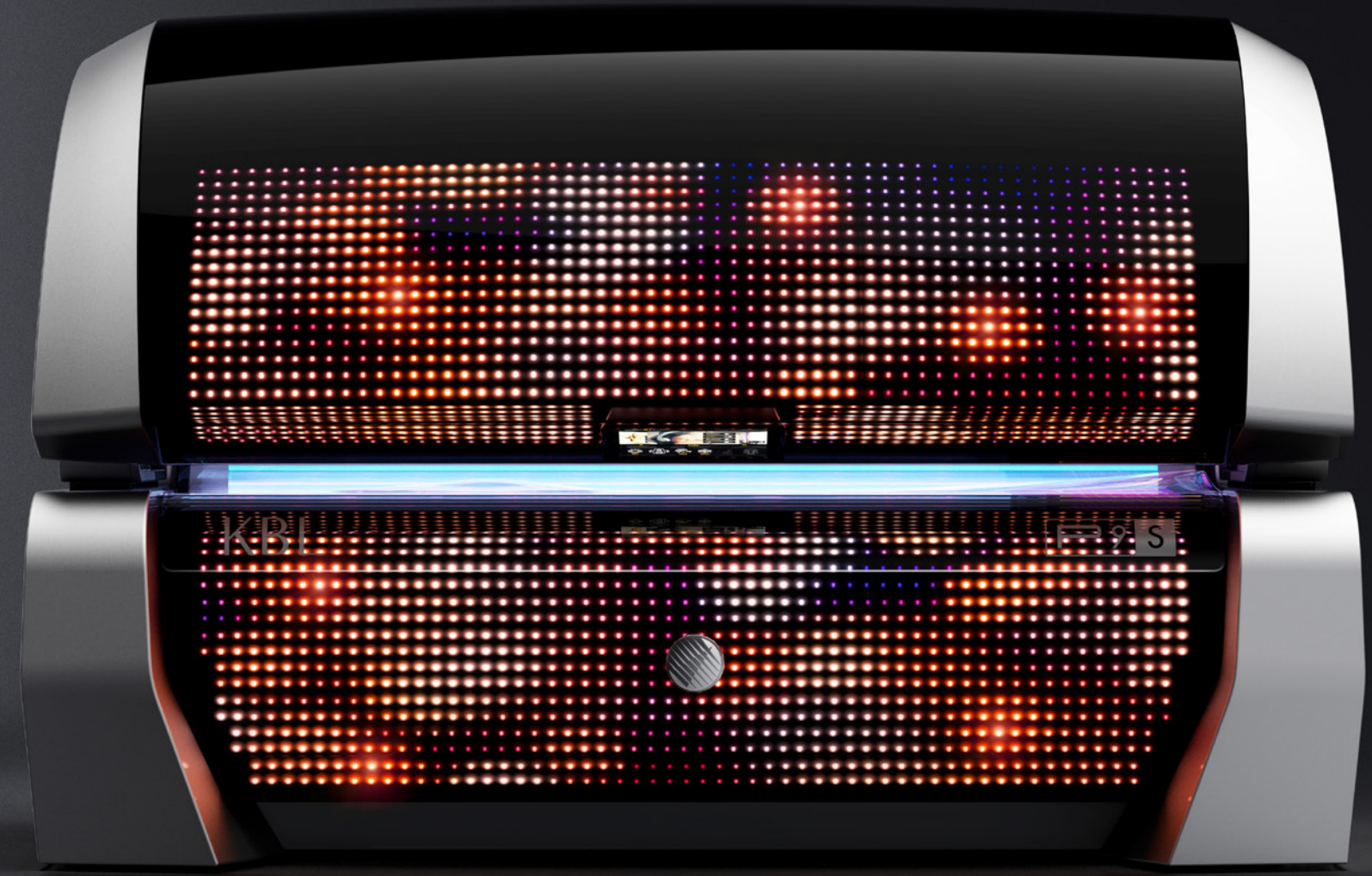

Design by
STUDIO F·A·PORSCHE

A STARGAZING LIGHT SHOW

The P9S with its matrix light show captivates from the very first moment. Over 2.400 individually controllable special LEDs allow extraordinary light animations in shape and color. The P9S comes standard with a wide variety of selectable light show programmes.



Matrix Light



KBL



TAILORED SUNLIGHT

A tanning performance that leaves nothing to be desired: the P9S is available in four optimized spectral combinations in the body area. With a focus on direct pigmentation, pigment build-up and skin soothing.



Light
Select



SunSphere
Facials



SunSphere
Shoulders



Design by
STUDIO F·A·PORSCHE



EASY TO USE

Customers love the consistent operating logic in all KBL solariums.
The P9S impresses with proven function icons in a new look, clearly structured and intuitive to operate. Ease of use par excellence.



Easy Control



SPECIAL TOUCH

Our Intelligent Control System in a new look: video clips introduce the P9S to your customers and point out the individually adjustable comfort features. Ahead of a session, personal preferences can be selected via the intuitive touch display. The operator has comfortable access to all important maintenance and service settings. Additionally, studio operators can also import customised video clips with advertising messages.



Video Player



Intelligent Control System





BREATHE. RELAX. ENJOY.

Air condition for an optimal climate during tanning. Aqua Cool with revitalizing water mist for a pleasant refreshing experience. Aromatization of the air for a soothing scent. Enjoying the sun completely relaxed.



Air Condition



Aqua Cool



Aroma



WIRELESS COMFORT

Standard in the P9S: Wireless charging for all suitable smartphones as a perfect addition to the Bluetooth function. Customers simply place the device on the corresponding icon and the smartphone immediately starts charging during the tanning session. Without any annoying cables.



Wireless Charging



Bluetooth

STRIKING OPTICS

Solarium design in the footsteps of the legendary Porsche 911. The design icon as envisioned by Ferdinand Alexander Porsche continues to fascinate people all over the world to this day. And thus the Studio F. A. Porsche was the ideal candidate for our ambitious P9 design project. The result: a unique design that captivates your customers. The 'Magic Silver' chassis color fascinates with a variety of selectable light show programmes.

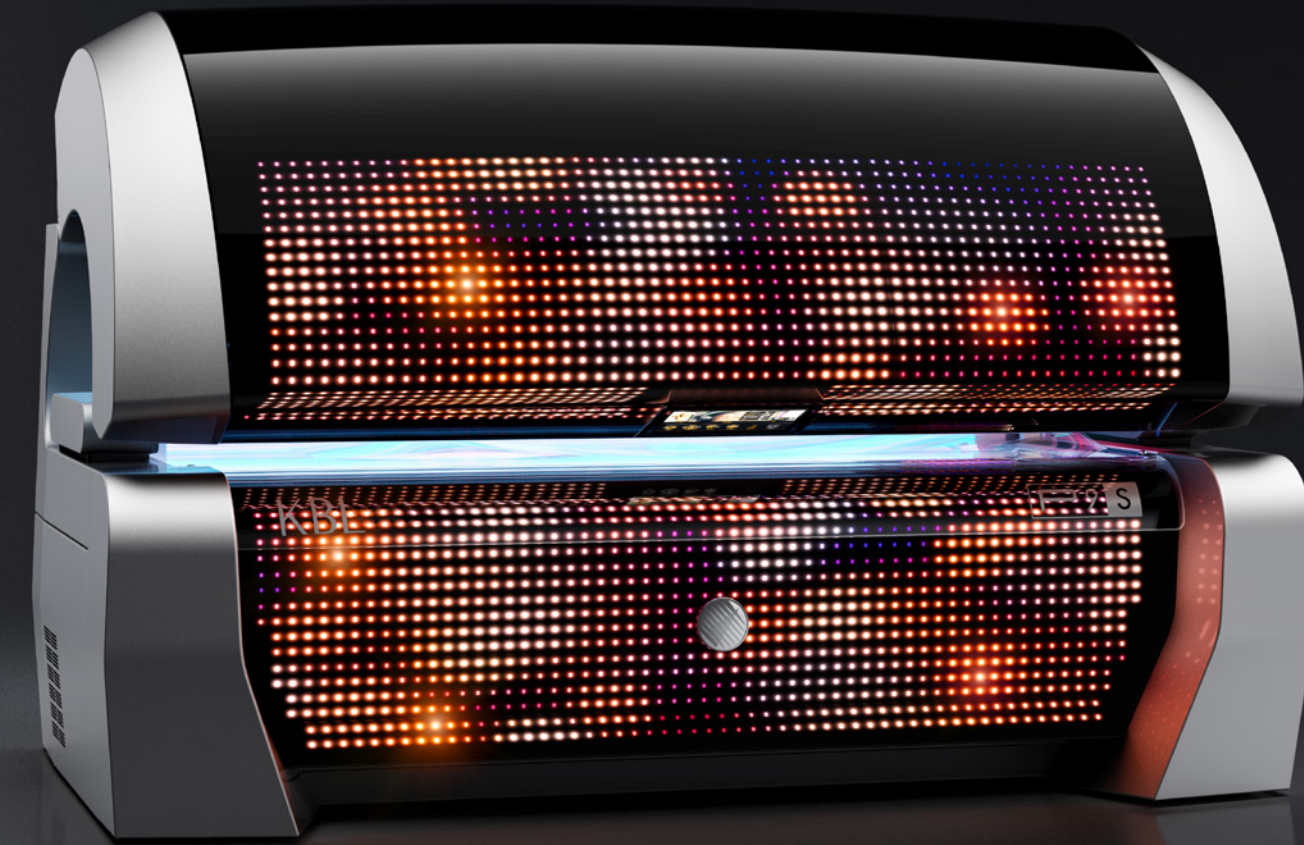

Design by
STUDIO F·A·PORSCHE

Magic Silver

RADIANT APPEARANCE

The right choice for all studio concepts: with the 'Wonder White' chassis color, the P9S is a real highlight in every spa atmosphere. Naturally with color-coordinated light animations that fascinate customers over and over again.



Wonder White



TRENDSETTER

The rose-gold color isn't just trendy for design icons like the iPhone. The characteristic copper shade communicates straightaway the premium aspiration of the P9S along with its color-coordinated light animations. And because two thirds of all solarium users are female, it's no surprise that our new 'Copper Rose' chassis color is the clear favourite of this target group in market research studies.

Design by
STUDIO F·A·PORSCHE

Copper Rose

THE POWER OF CHOICE.



P9S hybridSun

P9S extraSun



pureSunlight

Intensive sunlight for ideal tanning results.



smartSunlight

Intensive sunlight combined with soothing beauty light.



extraSunlight

Sunlight with a high percentage of UVB for increased pigment development.

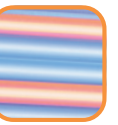

Beauty Booster HyperRed

Extra intensive beauty light for a beautiful skin.



SunSphere Facials

Perfectly balanced spectrum of UVA-LEDs, Beauty LEDs and UVB special lamps.

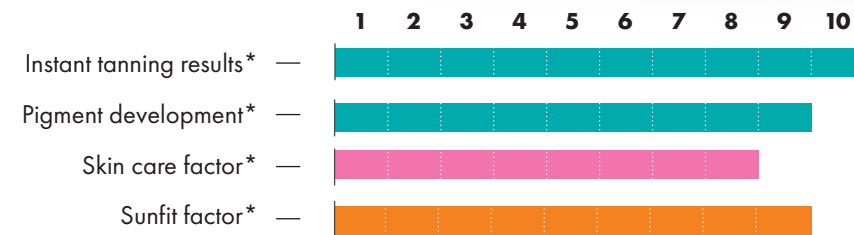
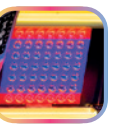

*Exemplary comparative depiction

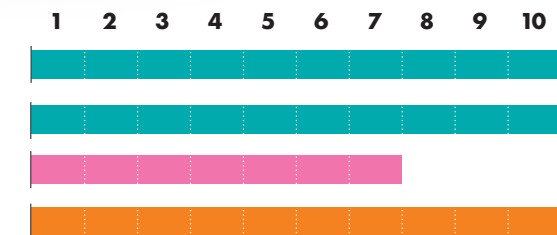
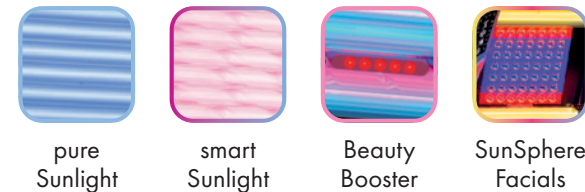

— Instant tanning results*
 — Pigment development*
 — Skin care factor*
 — Sunfit factor*

TECHNICAL DATA

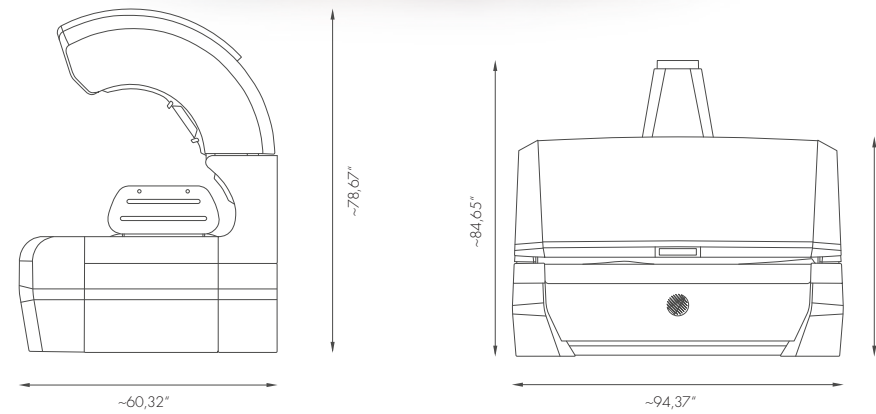

Maximum power consumption	12,5 kW
Weight	1477 lbs (with air condition)
Bed pane max. load capacity	330 lbs

Electrical connection values

Mains voltage	3-phase: 3 x 220 V / ~ / 60 Hz
Wire cross section	3-phase: 4 x AWG6
THHN cable in a isolation tubing (e.g. flexible metallic conduit, utilizing appropriate connectors)	
Breaker	3-pole, 3 x 50A with residual current

Ambient conditions – In dry rooms (booths) with sufficient airing and ventilation



Recommended room size:	10' (Width) x 9' (Depth)
Maximum relative air humidity:	70%
Maximum room temperature:	86°F (30°C)
Minimal distance to side walls:	4"
Minimum room height:	94,5"
Distance to backwall:	0"

Dimensions (inches) (height x width x depth)



Closed:	62,88" x 94,37" x 60,32" (84,65" h with exhaust)
Open:	78,67" x 94,37" x 59,14" (84,65" h with exhaust)

P9S

hybridSun

- 34 x 200 W (max.) pureSunlight lamps
 - 16 x 200 W (max.) smartSunlight lamps
 -  4 x 120 W (max.) SunSphere LED Facials
 -  2 x 20 W (max.) SunSphere LED Shoulders
 - 40 x Beauty Booster HyperRed LEDs
-

extraSun

- 44 x 200 W (max.) pureSunlight lamps
 - 6 x 200 W (max.) extraSunlight lamps
 -  4 x 120 W (max.) SunSphere LED Facials
 -  2 x 20 W (max.) SunSphere LED Shoulders
 - 40 x Beauty Booster HyperRed LEDs
-

Light Select options

SunSphere LEDs vs. High Pressure-Bulb



120 W Facials
20 W Shoulders

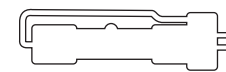

800 W HP-Bulb
250 W HP-Bulb

EXAMPLE: 120 W SUNSPHERE FACIALS ARE EQUAL TO THE TANNING PERFORMANCE OF A 800 W HIGH PRESSURE-BULB.

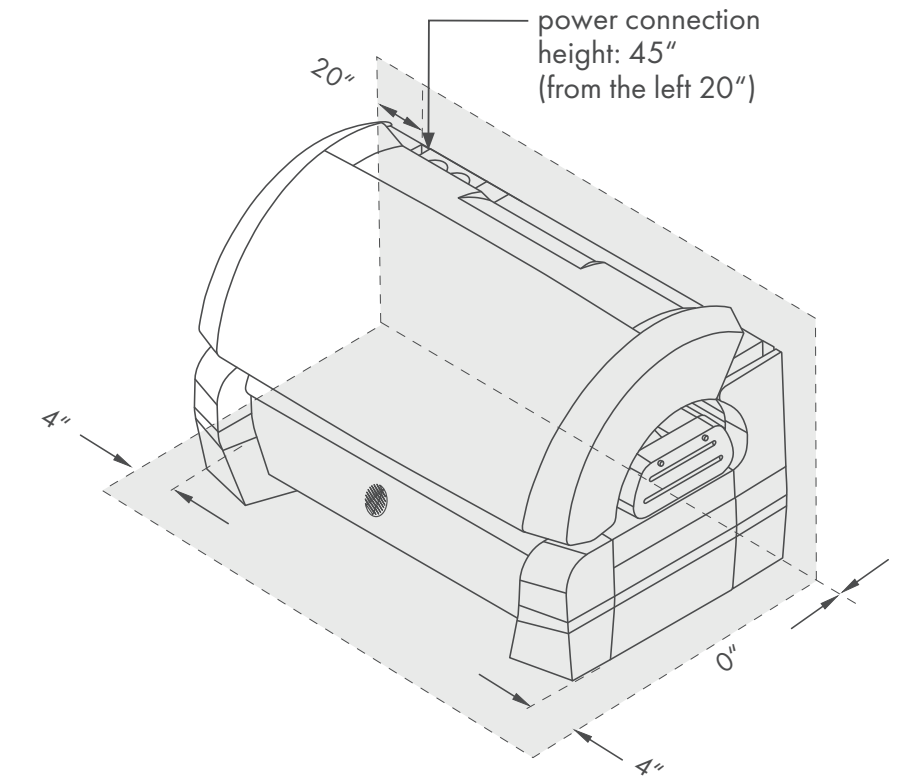



Design must be honest!

These four words spoken by Prof. Ferdinand Alexander Porsche get to the heart of his philosophy in which design is not simply decoration or superficial beautification, but rather the perfect symbiosis of form and function. This can only be achieved once the functionality of a product is fully captured.



When the studio was founded in 1972 in Zell am See, F. A. Porsche had already delivered the evidence of this philosophy: the design for the Porsche 911. An unembellished, timeless design that embodies the technical essence of the sports car like a perfectly tailored suit.

A passionate expression of motion – even when still. The fascination for puristic design still motivates Studio F. A. Porsche today. It permeates all the areas for which Studio F. A. Porsche designs objects in the 21st century: product, transport and space design.



KBL GmbH – Ringstraße 24-26 · 56307 Dernbach
fon +49 2689 - 94260 · fax +49 2689 - 942666 · e-mail: sales_northamerica@kbl.de

www.kbl-usa.com



Copyright 2020 KBL GmbH, Germany

Errors and omissions possible. KBL reserves the right to change technical data or specifications without notice.

Contraindication: This product is contraindicated for use on persons under the age of 18 years. "Contraindication: This product must not be used if skin lesions or open wounds are present." "Warning: This product should not be used on individuals who have had skin cancer or have a family history of skin cancer." "Warning: Persons repeatedly exposed to UV radiation should be regularly evaluated for skin cancer.